

# Cuisinart®

## INSTRUCTION BOOKLET



**Espresso Maker**

**EM-100C**

For your safety and continued enjoyment of this product, always read the instruction book carefully before using.

---

# IMPORTANT SAFEGUARDS

We at Cuisinart are very safety conscious. We design and manufacture consumer products with the safety of you, our valued customer, foremost in mind. In addition we ask that you exercise a degree of care when using electrical appliances and adhere to the following precautions.

When using electrical appliances, basic safety precautions should always be followed, including the following:

- CAREFULLY READ ALL INSTRUCTIONS BEFORE OPERATING APPLIANCE AND SAVE FOR FUTURE REFERENCE.**
- To protect against fire, electrical shock and injury to persons do not immerse the appliance, cord or plug in water or any other liquid.
- This appliance is for household use only.
- Do not use this appliance for anything other than its intended use.
- This appliance should not be used by or near children or individuals with certain disabilities.
- Do not leave the appliance unattended when in use.
- Do not touch hot surfaces. Use handles.
- Always use the appliance on a dry, level surface.
- To disconnect, turn all controls off, then remove plug from power outlet.
- Do not place this appliance on or near a hot gas or electric burner, or where it could touch a heated oven.
- Do not let the cord hang over the edge of a table or counter, touch hot surfaces or become knotted.
- The use of accessory attachments not recommended by Cuisinart may cause a risk of injury to persons, fire or electrical shock.
- Strictly follow cleaning and care instructions.
- Do not use this appliance for anything other than its intended use. Do not use in moving vehicles or boats.
- Do not use outdoors.
- Always switch the appliance off, and then remove plug from the power outlet when the appliance is not being used and before cleaning.
- An extension cord is not recommended. However, if one is needed, the extension cord should be a grounded type and its electrical rating must be the same or higher wattage as the appliance. Regularly inspect the supply cord, plug and actual appliance for any damage. If found damaged in any way, immediately cease use of the appliance and call Cuisinart Customer Service at 1-800-472-7606.
- For any maintenance other than cleaning, call Cuisinart Customer Service at 1-800-472-7606.
- Refer servicing to qualified personnel.
- Do not operate any appliance with a damaged cord or plug or after the appliance malfunctions, or has been damaged in any manner. Return appliance to the nearest authorized service facility for examination, repair or adjustment.
- Unplug from outlet when not in use and before cleaning. Allow to cool before putting on or taking off parts, and before cleaning the appliance.
- CAUTION:** Do not operate your appliance in an appliance garage or under a wall cabinet. When storing any appliance in an appliance garage always unplug the unit from the electrical outlet. Be sure the appliance does not touch the interior wall of the appliance garage, and the door does not touch the unit as it closes. Contact could cause the unit to turn ON, creating a risk of fire.

## SAVE THESE INSTRUCTIONS

---

# FOR HOUSEHOLD USE ONLY

## WARNING: RISK OF FIRE OR ELECTRIC SHOCK



The lightning flash with arrowhead symbol within an equilateral triangle is intended to alert the user to the presence of uninsulated dangerous voltage within the product's enclosure that may be of sufficient magnitude to constitute a risk of fire or electric shock to persons.



The exclamation point within an equilateral triangle is intended to alert the user to the presence of important operating and maintenance (servicing) instructions in the literature accompanying the appliance.

## SPECIAL SAFETY INSTRUCTIONS

1. Use only cold water in the water reservoir. Do not use any other liquid.
2. Never use the machine without water in it.
3. Ensure that the portafilter holder is firmly secured when using the machine.
4. Never remove the portafilter holder during the brewing operation as the machine is under pressure.

**NOTE:** For safety reasons it is recommended you plug your Cuisinart appliance directly into the power outlet. Use in conjunction with a power strip or extension cord is not recommended.

## SPECIAL CORD SET INSTRUCTIONS

A short power-supply cord is provided to reduce the risks resulting from becoming entangled in or tripping over a longer cord.

Longer extension cords are available and may be used if care is exercised in their use.

If a long extension cord is used, the marked electrical rating of the extension cord must be at least as great as the electrical rating of the appliance, and the longer cord should be arranged so that it will not drape over the countertop or tabletop where it can be pulled on by children or tripped over.

## NOTICE

This appliance has a polarized plug (one blade is wider than the other). To reduce the risk of electric shock, this plug will fit in a polarized outlet only one way. If the plug does not fit fully in the outlet, reverse the plug. If it still does not fit, contact a qualified electrician. Do not modify the plug in any way.

## IMPORTANT UNPACKING INSTRUCTIONS

1. Open the gift box.
2. Remove the top corrugated cardboard.
3. Remove the entire unit from the box.
4. Remove the three filter baskets, scoop/tamping tool and portafilter holder from the side polyfoam.
5. Remove the frothing pitcher from the middle of the espresso maker and then remove the polyfoam from the espresso maker.

We suggest you save all packing materials in the event that future shipping of the machine is needed. Keep all plastic bags away from children.

---

# CONTENTS

Important Safeguards. . . . .	2
Unpacking Instructions . . . . .	3
The Quest for the Perfect Cup of Espresso. . . . .	4
Features and Benefits, Diagram. . . . .	5
Preparing Your Espresso Machine Before Use . . . . .	6
Guide to the Perfect Espresso. . . . .	7
Guide to Milk Texturing . . . . .	8
Using the Hot Water Function . . . . .	8
Cleaning and Maintenance . . . . .	9
Recipes . . . . .	10
Warranty . . . . .	19

## INTRODUCTION

Congratulations on the purchase of your new Cuisinart® Espresso Maker! You're only minutes away from experiencing the rich, flavourful espresso found in the world's best cafés, right in your own home. Please take a few moments to discover the features of your new espresso maker, and be sure to enjoy every espresso, cappuccino and latte to come!

## THE QUEST FOR THE PERFECT CUP OF ESPRESSO

It is generally agreed that there are four basic elements critical to the perfect cup:

### Element 1: Water

When brewing espresso, make sure the water flows through the filter at the correct pace. The water flow can be adjusted by varying the pressure with which the coffee is tamped (pressed down) in the filter or by altering the grind of the coffee. If the speed of the water flow is too slow, the coffee will be over-extracted and will be very dark and bitter, with a spotted and uneven crema (froth) on the top. If the speed of the water flow is too fast, the coffee will be under-extracted and the supreme flavour will not develop. The coffee will be diluted and there will be an inadequate amount of crema on the top.

### Element 2: Coffee

While the bulk of the liquid is water, all of the flavour should be from the coffee. To achieve the same great quality of coffee you receive at a café, you need to use the same quality beans. If you choose to grind your own beans, buy the beans fresh and whole, only about a two-week supply at a time for maximum freshness. Once the coffee bean is broken, its flavour degrades very quickly. If it is not practical to buy smaller supplies, we recommend you separate larger amounts of beans and store them in airtight containers in a cool, dry area. They should not be kept for longer than 1 month as flavour will diminish. Do not refrigerate or freeze coffee beans.

### Element 3: Grind

The grind of the coffee is critical for proper flavour extraction. If using a pre-ground coffee, be sure to purchase an espresso grind that is specifically for espresso/cappuccino machines. If the grind is too fine, over-extraction and bitterness will occur with a spotted and uneven crema on the top. If the grind is too coarse, the water will pass through too rapidly and there will be an inadequate amount of crema on the top of the espresso.

### Element 4: Tamping the Coffee Grounds

If you choose to use ground espresso instead of pods, tamping the coffee is a very important part of the coffee making process. Use the scoop supplied to fill the filter basket, then using the tamping tool (flat end of the measuring scoop), tamp (press down) down on the grounds with moderate pressure. Add more coffee and tamp again if necessary to bring coffee to level. Do not overfill the filter basket. The ground coffee should be tamped with moderate pressure. If the coffee is not tamped securely, there is a chance that the water will flow through the coffee too rapidly and the coffee will be under-extracted. **Note: If the coffee is tamped too firmly, the water will flow through the coffee too slowly and the coffee will be over-extracted.**

# FEATURES AND BENEFITS

## 1. Water Reservoir Lid

## 2. Removable 53-ounce Water Reservoir



## 3. Large Cup-Warming Plate

## 4. 15 Bar Pump (not shown)

## 5. Red Heating Light

Will illuminate indicating that espresso machine is heating up to the appropriate temperature of the heating system.



## 6. Steam/Hot Water Knob

To use the hot water function, the Steam/Hot Water Knob must be turned to the  setting. To use the steam function, the steam/hot water knob must be turned to the  setting

## 7. Power Button

Used to turn the espresso maker on or off.

## 8. Large Function Knob

3 different settings: espresso () , off (O), and steam/hot water ( )

## 9. Portafilter Holder

Can be used with ground or pod espresso. Has two positions, lock and unlock, for ease of cleaning.

## 10. Brew Head

For easy fit of the portafilter holder.

## 11. Commercial Steam Wand

Used to steam milk for cappuccinos and lattes.

## 12. Removable Drip Tray

Removable drip tray with grate.

## 13. Cleaning Pins

Used to clean any excess milk that gets stuck inside the steam wand or any coffee particles that get stuck inside the filter basket.

## 14. Stainless Frothing Pitcher

Used for steaming milk for cappuccinos and lattes.

## 15. Measuring Scoop/Tamping Tool

Use one side as a coffee scoop and the other to compact the coffee grounds in the filter basket prior to brewing.

## 16. Filter Baskets (see below)

Use the (a) one-cup filter basket for a single espresso, the (b) two-cup filter basket for a double espresso or (c) the pod filter basket for espresso pods.

## 17. BPA Free (Not Shown)

All materials that come in contact with water or coffee are BPA Free.

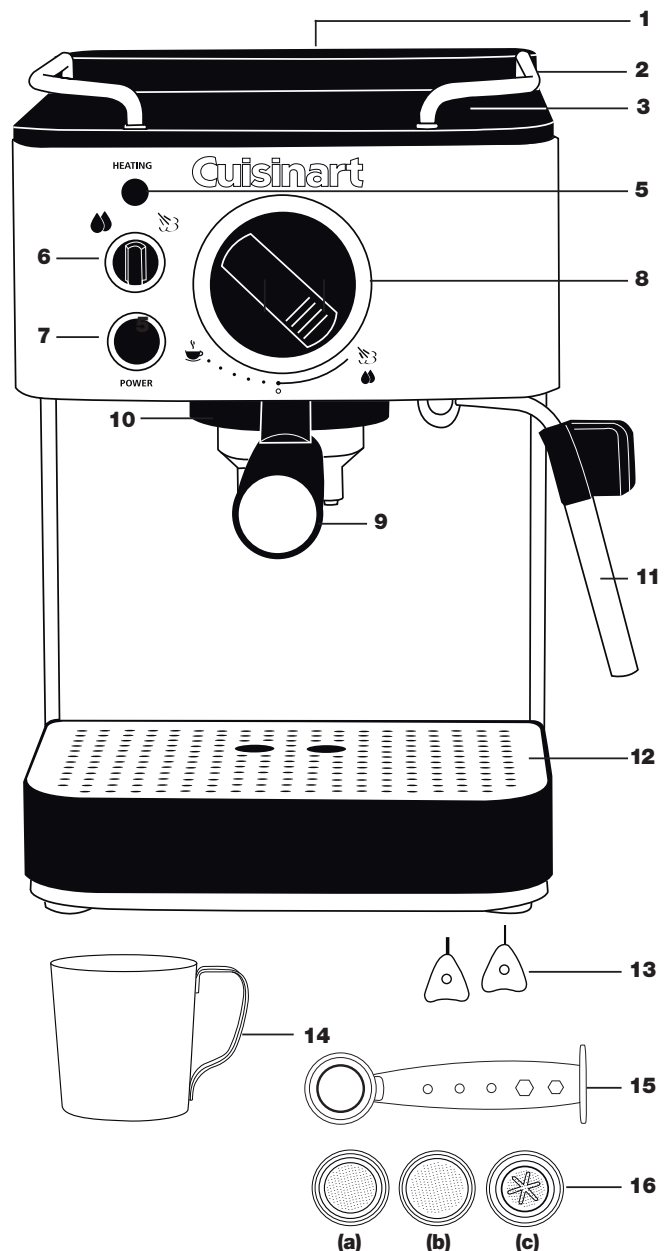

# PREPARING YOUR ESPRESSO MACHINE

1. Place the espresso machine on a dry, stable countertop or other surface where you will be using the machine.

**Important: For first time use or if the machine has not been used for some time, it is important that the machine is rinsed as follows:**

2. To fill the espresso machine with water. Simply lift the lid of the water reservoir at the top of the espresso machine (1) and fill with fresh cold water or filtered water (2).

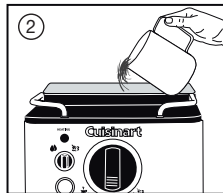
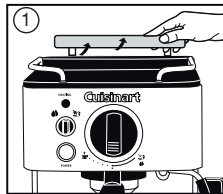

3. Make sure that the drip tray and grate are in place.

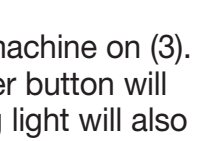

4. Insert the plug into a power outlet. Press the power button to turn the espresso machine on (3). The light located on the power button will illuminate red and the heating light will also illuminate red; this indicates that your espresso machine is on and is heating up. When the heating light switches off, this indicates that the espresso machine is heated and ready to use (4).

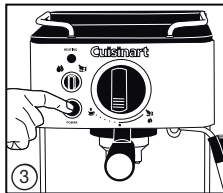

5. Place cups on the warming plate (5).

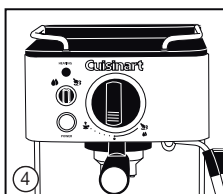

6. Fit the portafilter handle with either the one or two cup or pod filter basket (6). Secure the portafilter handle to the brew head (7-8).

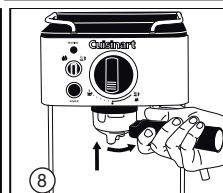
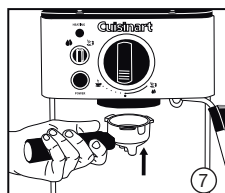
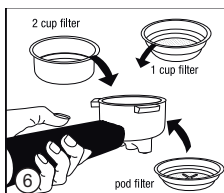
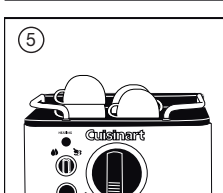

7. Place a sufficiently large container under both pouring spouts (9).

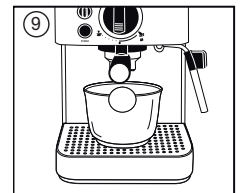

8. Turn the large function knob to the espresso setting (10) and turn the steam/hot water knob to the position. Allow the water to run through until the water reservoir is empty.

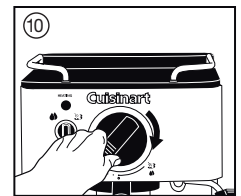

## USING THE CONTROL PANEL

### Power

**NOTE:** Before turning on the espresso machine, make sure that the large function knob is in the off position.

Press the power button to turn the espresso machine on. The light located on the power switch will illuminate red and the heating light will illuminate red; this is to indicate that your espresso machine is on and is heating up.

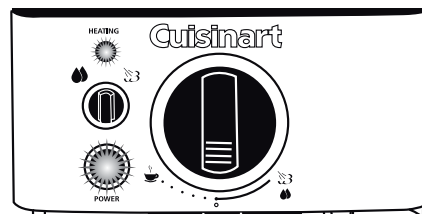

The espresso machine will automatically adjust the temperature of the heating system to the espresso temperature. When the machine is heated and ready to use, the red heating light will go out.

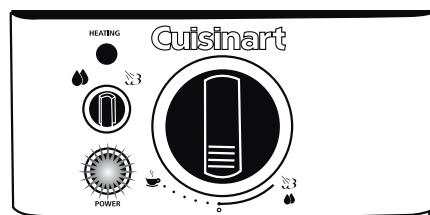



**NOTE:** To turn the espresso machine off, simply press the power button.

### Espresso



When the machine's heating system has reached the correct temperature so that the red heating light is off, you can use the espresso machine. Simply turn the large function knob clockwise to the espresso setting to start the pour and turn it back to the off position to stop.

## Steam/Hot Water

When the espresso machine is switched on, use the steam/hot water knob to select either the steam  or hot water  function.

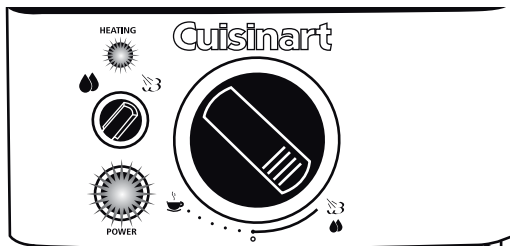
- A. If you want to froth milk for cappuccinos and lattes, you must turn the steam/hot water knob to the steam  setting and turn the function knob to the steam/hot water setting. The red heating light will illuminate, indicating that the espresso machine is adjusting the temperature of the heating system.



- B. If you want to use the hot water function, you must turn the steam/hot water knob to the hot water  setting and turn the function knob to the steam/hot water setting  . The red heating light will illuminate indicating that the espresso machine is adjusting the temperature of the heating system.

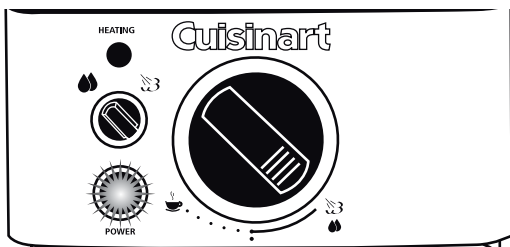

When you are finished with the steam/hot water function, turn the large function knob clockwise back to the center position and you are ready to make espresso.

## GUIDE TO THE PERFECT ESPRESSO

1. You may want to preheat the cups by filling them with hot water; this will help preserve the crema of the espresso. Set the cups aside.

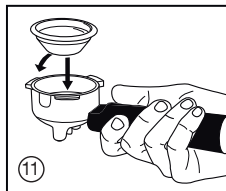

2. Select the appropriate filter basket and insert it into portafilter handle (11).

**TIP:** Use the one-cup filter basket for a single espresso and the two-cup filter basket for a double espresso and pod filter for an espresso pod.

3. Using the measuring scoop, spoon finely ground coffee in the filter basket (12). Use one scoop for one cup or two scoops for two cups, or place espresso pod into filter basket.

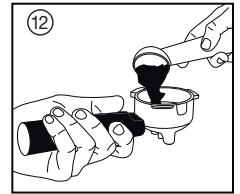

4. Using the tamping tool, apply moderate packing pressure (13). Add more coffee and tamp again if necessary to bring coffee to level.

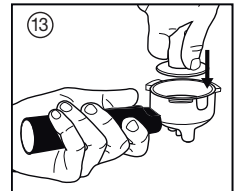

5. Brush any excess coffee grounds from around the edge of the filter basket (14).

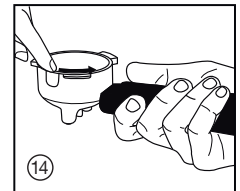

**IMPORTANT:** Be sure not to overfill the filter basket with coffee.

**TIP:** Make sure the tamping tool is dry so that wet coffee grinds do not stick to it.

6. Secure the portafilter holder onto the brew head (15-16).

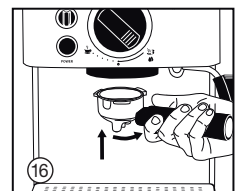
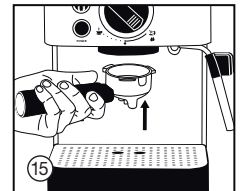

**NOTE:** Check to see that the espresso machine is ready for use. Remember that if the heating light is on, the espresso machine is still adjusting the temperature of the heating system.

7. Turn the large function knob clockwise to the espresso setting to start the pour and turn it back to the off position to stop (17).

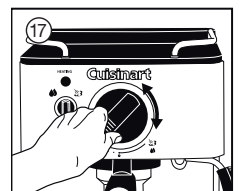

8. Check the espresso pour. The ideal pour is dark and caramel with reddish reflections.
9. Serve espresso immediately.

## Caring for your Espresso Machine

10. Remove the portafilter handle from the brew head (18).

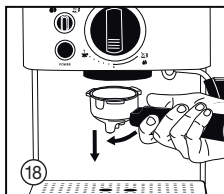

11. Discard the used coffee grinds or pod/pods from the filter basket (19). Place the portafilter holder into the slide lock position when discarding grinds so basket stays in place.

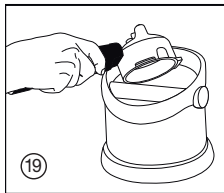

## GUIDE TO MILK TEXTURING

Milk texturing is the steaming of milk. The steam does two things; it heats the milk and mixes air with the milk to form a creamy texture. As with learning to make an espresso, perfecting the art of milk texturing takes time and practice.

Before starting to prepare for milk texturing, make sure that the steam/hot water knob is in the steam setting.

1. Determine how much milk is needed based on the number of cups being made.

**TIP:** Keep in mind that the volume of milk will increase during the texturing.

2. Pour cold refrigerated milk into the stainless frothing pitcher, approximately ½ full.

3. Purge the steam wand of any water. With the steam wand positioned over the drip tray, activate the steam function by turning the large function knob to the steam setting (20). Once any water has been purged, stop the steam by turning the large function knob to the off position (21).

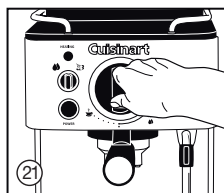
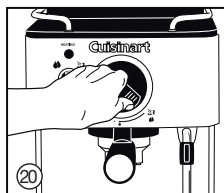

4. Swing the steam wand to the side of the espresso machine (22).

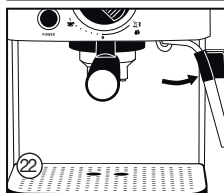

5. Place the steam wand into the milk so that the nozzle is about a half-inch (1.25 cm) below the surface and activate

the steam function by turning the function knob to the steam setting (23).

6. Angle the pitcher so that the steam wand is resting on the spout of the pitcher and lower the pitcher until the tip of the steam nozzle is just below the surface of the milk. This will start to create a whirlpool action in the milk (24).

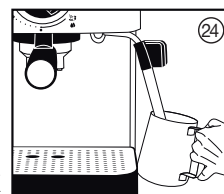
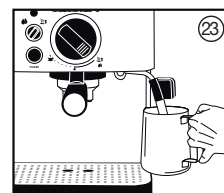

**NOTE:** Do not allow the steam to spurt unevenly or it will create aerated froth/large bubbles. If this is happening, raise the pitcher so that the steam nozzle is lowered farther into the milk.

7. As the steam heats and textures the milk, the level of the milk in the pitcher will begin to rise. As this happens, follow the level of the milk by lowering the pitcher, always keeping the tip of the steam nozzle just below the surface.

8. Once the foam is created, raise the pitcher until the steam nozzle is in the centre of the milk (25).

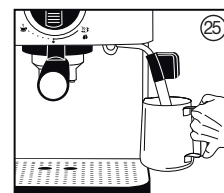

**TIP:** The amount of foam required will vary depending on the drinks being made; for example, a cappuccino requires more foam than a latte.

9. Stop the steam immediately when the milk is heated by turning the large function knob to the off position (26).

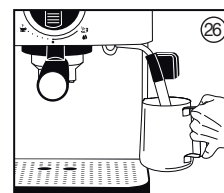

**IMPORTANT:** Do not boil the milk.

10. Remove the pitcher, immediately wipe the steam nozzle and wand with a clean damp cloth (27) and purge a small amount of steam.

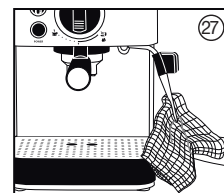

## USING THE HOT WATER FUNCTION

When using the hot water function make sure that the steam/hot water knob is in the hot water setting.



1. Place the cup or container under the steam/hot water nozzle and turn the function knob to the  setting (28).

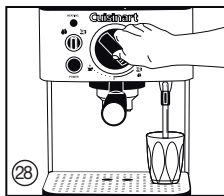

2. Once you have dispensed the required amount of hot water into the cup or container, stop the hot water by turning the large function knob to the off position (29).

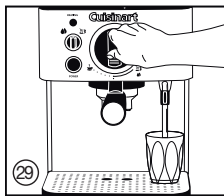

3. Remove the cup or container and swing the steam/hot water wand over the drip tray to catch any drips of water (30).

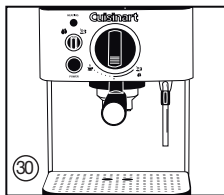

- The drip tray can be washed in warm soapy water and rinsed thoroughly. Use a non-abrasive washing liquid. Do not use any scouring agents or harsh cleaners.

**NOTE:** Do not clean any of the parts or accessories in the dishwasher.

### CLEANING THE STEAM WAND

- The steam wand should always be cleaned after steaming milk.
- Wipe the steam wand with a damp cloth, then with the steam wand directed back into the drip tray, momentarily set the function knob to the hot water setting. This will release any remaining milk from inside the steam wand.
- Ensure the large function knob is in the off position. Press the power button off, unplug the power cord and allow the machine to cool.
- If the steam wand remains blocked, use a cleaning pin to clear the opening.

## CLEANING AND MAINTENANCE

Always turn the Espresso Maker off and remove the plug from the electrical outlet before cleaning.

Never immerse unit in water or other liquid. To clean, simply wipe with a clean damp cloth and dry before storing.

### CLEANING THE FILTERS, PORTAFILTER HOLDER AND BREW HEAD

- The stainless steel filters and portafilter holder should be rinsed under water immediately after use to remove all coffee particles. You may also use a cleaning pin to clean the opening.
- Periodically run water through the machine with the portafilter holder in place, but without any ground coffee, to rinse out any lingering coffee particles. The inside of the brew head should be wiped with a damp cloth to remove any coffee particles.

### CLEANING THE OUTER HOUSING/CUP WARMING PLATE

- The outer housing and cup warming plate can be cleaned with a soft, damp cloth. Do not use any scouring agents or harsh cleaners.

### CLEANING THE DRIP TRAY

- The drip tray can be removed after the grate is removed and then cleaned with a soft, damp cloth. Do not use any scouring agents or harsh cleaners.

### DECALCIFICATION

Decalcification refers to the removal of calcium deposits that form over time on the metal parts of the coffeemaker.

For best performance from your espresso maker, decalcify the unit from time to time. The frequency depends on the hardness of your tap water and how often you use the coffeemaker. To clean, fill the water reservoir to capacity with a mixture of  $\frac{1}{3}$  white vinegar and  $\frac{2}{3}$  water. Be sure the power button is in the off position, and the unit is unplugged. Remove the portafilter holder. Pour the decalcifying agent into the water reservoir, plug the machine back in, and power the unit back on. Set the power button to on and the large function knob to the off position. Place a large container under the brew head and steam wand. When brewing temperature is reached, the heating light will switch off. Set the large function knob to the espresso position  and let half of the solution run through the brew head. Set the large function knob to steam position and allow the remaining solution to run through the steam wand. When the solution stops running, set the large function knob back to the off position. After decalcifying, let one cycle of fresh cold water through the unit before using the unit again to brew coffee. Any other servicing should be performed by an authorized service representative.

---

# RECIPES

## Classic Espresso

Makes 1 serving (1½ ounces)

- 1 measured scoop finely ground espresso or 1 espresso pod**

Place the one-cup filter basket in the portafilter holder. Spoon the espresso grounds into the filter basket. Using the tamping tool, press down the grounds with moderate pressure and clean any excess from the rim.

Turn the Cuisinart® Espresso Maker on. When the machine is heated and ready to use, the red heating light will go out. Secure the portafilter holder in place.

Place a demitasse cup underneath the brew head and turn the function knob to the espresso setting. ☕

Espresso will begin to brew. When 1½ ounces have been brewed (after about 15 seconds), turn the large function knob to the off position.

## Doppio

Makes 1 serving (3 ounces)\*

- 2 measured scoops finely ground espresso or 2 espresso pods**

Place the two-cup filter basket in the filter holder. Spoon the espresso grounds into the basket. Using the tamping tool, press down the grounds with moderate pressure and clean any excess from the rim.

Turn the Cuisinart® Espresso Maker on. When the machine is heated and ready to use, the red heating light will go out. Secure the portafilter holder in place.

Place one mug or glass underneath the brew head and turn the knob to the espresso ☕ function. Espresso will begin to brew and when 3 ounces have been brewed (after about 25 seconds), turn the large function knob to the off position.

\*This could also be used to make two single espressos. Follow the same instructions for the Doppio, but place two demitasse cups under the brew head instead of one.

## Americano

Makes 1 serving (6-8 ounces)

- 1 measured scoop finely ground espresso or 1 espresso pod**

- 6-7 ounces hot water**

Turn the Cuisinart® Espresso Maker on. When the machine is heated and ready to use, the red heating light will go out. Place the one-cup filter basket in the portafilter holder. Spoon the espresso grounds into the filter basket. Using the tamping tool, press down the grounds with moderate pressure and clean any excess from the rim. Secure the filter holder in place.

Turn the steam/hot water knob to the hot water setting. ☕ Place a 6 to 8 ounce glass or mug on the drip tray underneath the steam wand. Turn the function knob to the steam/hot water setting. ☕☕☕ and allow water to flow into the cup/mug until it is about ⅔ full. Turn the large function knob to the off position.

Place the cup/mug with the hot water already in it underneath the brew head and turn the function knob to the espresso ☕ function. Espresso will begin to brew. When 1½ ounces have been brewed (after about 15 seconds), turn the large function knob to the off position.

## Espresso con Panna

Makes 1 serving (1½ ounces)

- 1 measured scoop finely ground espresso or 1 espresso pod**

- ¼ cup (125 ml) heavy cream, whipped to a medium-soft peak, kept in refrigerator**

Place the one-cup filter basket in the portafilter holder. Spoon the espresso grounds into the filter basket. Using the tamping tool, lightly press down the grounds with moderate pressure and clean any excess from the rim.

---

Turn the Cuisinart® Espresso Maker on. When the machine is heated and ready to use, the red heating light will go out.

Secure the portafilter holder in place. Place a demitasse cup underneath the brew head and turn the function knob to the ☕ espresso function. Espresso will begin to brew. When 1½ ounces have been brewed (after about 15 seconds), turn the large function knob to the off position.

Take whipped cream out of refrigerator and spoon about 1 tablespoon (15 ml) on top of espresso.

## Espresso Macchiato

Makes 1 serving (1½ ounces)

- 2 ounces (60 ml) skim milk**
- 1 measured scoop finely ground espresso or 1 espresso pod**

Pre-chill the frothing pitcher. Turn the Cuisinart® Espresso Maker on. When the machine is heated and ready to use, the red heating light will go out. Place the one-cup filter basket in the portafilter holder. Spoon the espresso grounds into the filter basket. Using the tamping tool, press down the grounds with moderate pressure and clean any excess from the rim.

Turn both the steam/hot water and function knobs to the ☁ steam settings. Pour the milk into the pre-chilled frothing pitcher. Hold the pitcher in one hand and place under the steam wand so the bottom of the wand is just below the surface of the milk. While holding the pitcher at an angle, allow the steam to move the milk around. Once the milk begins to increase in volume, lift the pitcher higher so the steam wand is immersed farther into the milk. Move the pitcher up and down a couple of times to achieve a nice foam. When the foam has almost reached the top of the pitcher, turn the large function knob to the off position. Reserve steamed/frothed milk.

Wait for the red heating light to go out, if necessary.

Secure the portafilter holder in place. Place a demitasse cup underneath the brew head and turn the function knob to the ☕ espresso setting. Espresso will begin to brew. When 1½ ounces have been brewed (after about 15 seconds), turn the large function knob to the off position.

Using a large spoon, spoon one tablespoon (15 ml) of the frothed milk on top of the espresso.

## Espresso Breve

Makes 1 serving (3½ ounces)

- ¼ cup (50 ml) half & half**
- 1 measured scoop finely ground espresso or 1 espresso pod**

Place the one-cup filter basket in the portafilter holder. Spoon the espresso grounds into the filter basket. Using the tamping tool, press down the grounds with moderate pressure and clean any excess from the rim.

Turn the Cuisinart® Espresso Maker on. When the machine is heated and ready to use, the red heating light will go out.

Secure the portafilter holder in place. Place one demitasse cup underneath the brew head and turn the function knob to the ☕ espresso setting. Espresso will begin to brew and when 1½ ounces have been brewed (after about 15 seconds), turn the large function knob to the off position.

Pour the half & half into a microwave-safe glass or mug. Place in microwave on high for 1 minute. Pour the espresso into the same mug.

---

## Cappuccino

Makes 1 serving (3½ ounces)

- 2 ounces (60 ml) skim milk**
- 1 measured scoop finely ground espresso or 1 espresso pod**

Pre-chill the frothing pitcher. Place the one-cup filter basket in the portafilter holder. Spoon the espresso grounds into the filter basket. Using the provided tamping tool, press down the grounds with moderate pressure and clean any excess from the rim. Secure the portafilter holder in place.

Turn the Cuisinart® Espresso Maker on. When the machine is heated and ready to use, the red heating light will go out.

Turn both the steam/hot water and function knobs to the  steam setting. Pour the milk into the pre-chilled frothing pitcher. Hold the pitcher in one hand and place under the steam wand so the bottom of the wand is just below the surface of the milk. While holding the pitcher at an angle, allow the steam to move the milk around. Once the milk begins to increase in volume, lift the pitcher higher so the steam wand is immersed farther into the milk. Move the pitcher up and down a couple of times to achieve a nice foam. When the foam has almost reached the top of the pitcher, turn the large function knob to the off position. Reserve steamed/frothed milk.

Wait for the red heating light to go out, if necessary.

Place one cappuccino cup or glass underneath the brew head and turn the function knob to the  espresso setting. Espresso will begin to brew. When 1½ ounces have been brewed (after about 15 seconds), turn the large function knob to the off position.

Using a large spoon, spoon 2 to 3 tablespoons (30-45 ml) of frothed milk on top of the espresso.

## Café Latte

Makes 1 serving (5½ ounces)

- 4 ounces (115 ml) skim milk**
- 1 measured scoop finely ground espresso or 1 espresso pod**

Pre-chill the frothing pitcher. Place the one-cup filter basket in the portafilter holder. Spoon the espresso grounds into the filter basket. Using the tamping tool, press down the grounds with moderate pressure and clean any excess from the rim. Secure the portafilter holder in place.

Turn the Cuisinart® Espresso Maker on. When the machine is heated and ready to use, the red heating light will go out.

Turn both the steam/hot water and function knobs to the  steam setting. Pour the milk into the pre-chilled frothing pitcher. Hold the pitcher in one hand and place under the steam wand so the bottom of the wand is just below the surface of the milk. While holding the pitcher at an angle, allow the steam to move the milk around. Once the milk begins to increase in volume, lift the pitcher higher so the steam wand is immersed farther into the milk. Move the pitcher up and down a couple of times to achieve a nice foam. When the foam has almost reached the top of the pitcher, turn the large function knob to the off position. Reserve steamed/frothed milk. Wait for the red heating light to go out, if necessary.

Place a glass underneath the brew head and turn the function knob to the  espresso setting. Espresso will begin to brew. When 1½ ounces have been brewed, (after about 15 seconds), turn the large function knob to the off position.

Slowly pour the steamed milk into the glass to ½ inch below the top.

---

## Mochaccino

Makes 1 serving (5½ ounces)

- 4 ounces (115 ml) skim milk**
- 1 measured scoop finely ground espresso or 1 espresso pod**
- 2 tablespoons (30 ml) chocolate syrup**
- 1 tsp (5 ml) shaved bittersweet chocolate, or unsweetened cocoa powder for garnish (optional)**

Pre-chill the frothing pitcher. Place the one-cup filter basket in the portafilter holder. Spoon the espresso grounds into the filter basket. Using the tamping tool, press down the grounds with moderate pressure and clean any excess from the rim. Secure the portafilter holder in place.

Turn the Cuisinart® Espresso Maker on. When the machine is heated and ready to use, the red heating light will go out.

Turn both the steam/hot water and function knobs to the ☺ steam settings. Pour the milk in the pre-chilled frothing pitcher. Hold the pitcher in one hand and place under the steam wand so the bottom of the wand is just below the surface of the milk. While holding the pitcher at an angle, allow the steam to move the milk around. Once the milk begins to increase in volume, lift the pitcher higher so the steam wand is immersed farther into the milk. Move the pitcher up and down a couple of times to achieve a nice foam. When the foam has almost reached the top of the pitcher, turn the large function knob to the off position. Reserve steamed/frothed milk.

Wait for the red heating light to go out, if necessary.

Place a glass underneath the brew head and turn the function knob to the ☹ espresso setting. Espresso will begin to brew. When 1½ ounces have been brewed (after about 15 seconds), turn the large function knob to the off position.

Add the chocolate syrup and about 4 ounces (115 ml) of the steamed milk; stir. Spoon 1 to 2 tablespoons (12-30 ml) of the frothed milk on

top. If desired, top with shaved chocolate or cocoa powder.

## Café Mocha

Makes 1 serving (6 ounces)

- 4 ounces (115 ml) skim milk**
- 1 measured scoop finely ground espresso or 1 espresso pod**
- 1 tablespoon (15 ml) chocolate syrup**
- ¼ cup (50 ml) heavy cream, whipped to a medium-soft peak**
- 1 tsp (5 ml) shaved bittersweet chocolate, or unsweetened cocoa powder for garnish (optional)**

Pre-chill the frothing pitcher. Place the one-cup filter basket in the portafilter holder. Spoon the espresso grounds in the filter basket. Using the tamping tool, press down the grounds with moderate pressure and clean any excess from the rim. Secure the portafilter holder in place.

Turn the Cuisinart® Espresso Maker on. When the machine is heated and ready to use, the red heating light will go out.

Turn both the steam/hot water and function knobs to the ☺ steam settings. Pour the milk into the pre-chilled frothing pitcher. Hold the pitcher in one hand and place under the steam wand so the bottom of the wand is just below the surface of the milk. While holding the pitcher at an angle, allow the steam to move the milk around. Once the milk begins to increase in volume, lift the pitcher higher so the steam wand is immersed farther into the milk. Move the pitcher up and down a couple of times to achieve a nice foam. When the foam has almost reached the top of the pitcher, turn the large function knob to the off position. Reserve steamed/frothed milk.

Wait for the red heating light to go off again, if necessary.

Place a demitasse cup underneath the brew head and turn the function knob to the ☹ espresso setting. Espresso will begin to brew. When 1½ ounces have been brewed (after

---

about 15 seconds), turn the large function knob to the off position

Fill a tall glass with the steamed milk, leaving about 2 inches (5 cm) at the top. Add the espresso and chocolate syrup. Top the drink off with about 2 tablespoons (30 ml) of the whipped cream.

If desired, top with shaved chocolate or cocoa powder.

## Espresso Lachino

Makes 1 serving (3 ounces)

- 2 ounces (60 ml) skim milk**
- 1 measured scoop finely ground espresso or 1 espresso pod**

Pre-chill the frothing pitcher. Place the one-cup filter basket in the filter holder. Spoon the espresso grounds into the filter basket. Using the tamping tool, press down the grounds with moderate pressure and clean any excess from the rim. Secure the portafilter holder in place.

Turn the Cuisinart® Espresso Maker on. When the machine is heated and ready to use, the red heating light will go out.

Turn both the steam and function knobs to the  steam setting. Pour the milk into the pre-chilled frothing pitcher. Hold the pitcher in one hand and place under the steam wand so the bottom of the wand is just below the surface of the milk. While holding the pitcher at an angle, allow the steam to move the milk around. Once the milk begins to increase in volume, lift the pitcher higher so the steam wand is immersed farther into the milk. Move the pitcher up and down a couple of times to achieve a nice foam. When the foam has almost reached the top of the pitcher, turn the large function knob to the off position. Reserve steamed/frothed milk.

Wait for the red heating light to go off again, if necessary.

Place a glass underneath the brew head and turn the function knob to the  espresso setting. Espresso will begin to brew and when

1½ ounces have been brewed (after about 15 seconds), turn the large function knob to the off position.

Slowly pour 1½ ounces (43 ml) of the steamed milk down the side of the glass. Top with 2 tablespoons (30 ml) of the frothed milk.

## Iced Cappuccino

Makes 1 serving (4½ ounces)

- 2 ounces (60 ml) skim milk**
- 1 measured scoop finely ground espresso or 1 espresso pod**
- 3-4 ice cubes**
- 3 ounces (90 ml) cold whole milk**

Pre-chill the frothing pitcher. Place the one-cup filter basket in the portafilter holder. Spoon the espresso grounds into the filter basket. Using the tamping tool, press down the grounds with moderate pressure and clean any excess from the rim. Secure the portafilter holder in place.

Turn the Cuisinart® Espresso Maker on. When the machine is heated and ready to use, the red heating light will go out.

Turn both the steam/hot water and function knobs to the  steam setting. Pour the milk into the pre-chilled frothing pitcher. Hold the pitcher in one hand and place under the steam wand so the bottom of the wand is just below the surface of the milk. While holding the pitcher at an angle, allow the steam to move the milk around. Once the milk begins to increase in volume, lift the pitcher higher so the steam wand is immersed farther into the milk. Move the pitcher up and down a couple of times to achieve a nice foam. When the foam has almost reached the top of the pitcher, turn the large function knob to the off position. Reserve steamed/frothed milk.

Wait for the red heating light to go off again, if necessary.

Place a demitasse cup underneath the brew head and turn the function knob to the  espresso setting. Espresso will begin to brew

---

and when 1½ ounces have been brewed (after about 15 seconds), turn the large function knob to the off position.

In a tall glass, place 3 to 4 ice cubes. Pour the espresso over the ice; add the whole milk. Spoon 2 tablespoons (30 ml) of the frothed milk on top.

## Frozen Espresso

Makes 1 serving (8 ounces)

- 2 measured scoops finely ground espresso or 2 espresso pods**
- 1 teaspoon (5 ml) granulated sugar**
- 2 ice cubes**

Place the two-cup filter basket in the portafilter holder. Spoon the espresso grounds into the filter basket. Using the tamping tool, press down the grounds with moderate pressure and clean any excess from the rim.

Turn the Cuisinart® Espresso Maker on. When the machine is heated and ready to use, the red heating light will go out.

Secure the portafilter holder in place. Place a glass underneath the brew head and turn the function knob to the  espresso setting. Espresso will begin to brew and when 3 ounces have been brewed (after about 25 seconds), turn the large function knob to the off position.

Stir the sugar into the hot espresso and stir to dissolve. Pour the espresso/sugar mixture into the jar of a Cuisinart® Blender. Place the lid on and process on high. While the motor is running, drop the ice cubes in and continue to process until the mixture is homogenous, about 20 seconds.

Pour into a glass.

## Frozen Latte

Makes 1 serving (8 ounces)

- 2 measured scoops finely ground espresso or 2 espresso pods**
- 1 teaspoon (5 ml) granulated sugar**

- 2 tablespoons (30 ml) whole milk**

- 3 ice cubes**

Place the two-cup filter basket in the portafilter holder. Spoon the espresso grounds into the filter basket. Using the tamping tool, press down the grounds with moderate pressure and clean any excess from the rim.

Turn the Cuisinart® Espresso Maker on. When the machine is heated and ready to use, the red heating light will go out.

Secure the portafilter holder in place. Place a glass underneath the brew head and turn the function knob to the  espresso setting. Espresso will begin to brew and after 3 ounces have been brewed (after about 25 seconds), turn the large function knob to the off position.

Add the sugar to the hot espresso and stir to dissolve. Pour the espresso mixture and the milk into the jar of a Cuisinart® Blender. Place the lid on and process on high. While the motor is running, drop the ice cubes in and continue to process until the mixture is homogenous, about 30 seconds.

Pour into a glass.

## Espresso Martini

Makes 4 servings

- 2 measured scoops finely ground espresso or 2 espresso pods**
- ¾ cup (175 ml) vodka**
- ½ cup + 1 tablespoon (140 ml) Kahlua®**
- ¼ cup + 1 tablespoon (65 ml) Tia Maria®**
- 6-8 ice cubes**

Place the two-cup filter basket in the portafilter holder. Spoon the espresso grounds into the filter basket. Using the tamping tool, press down the grounds with moderate pressure and clean any excess from the rim.

Turn the Cuisinart® Espresso Maker on. When the machine is heated and ready to use, the red heating light will go out.

---

Secure the portafilter holder in place. Place a glass underneath the brew head and turn the function knob to the ☕ espresso setting. Espresso will begin to brew. After ½ cup has been brewed (after about 30 seconds), turn the large function knob to the off position. Cover and refrigerate the brewed espresso.

When espresso has fully chilled, pour it into a cocktail shaker filled with ice and add the liquors. Shake and strain into individual espresso glasses.

## Granita

Makes 4 servings

- 4 measured scoops finely ground espresso or 4 espresso pods**
- 2 teaspoons (10 ml) granulated sugar**
- 2 cups (500 ml) heavy cream, whipped to a stiff peak**
- 1 tsp (5 ml) shaved bittersweet or semisweet chocolate (optional)**

Place the two-cup filter holder in the portafilter holder. Spoon the espresso grounds into the filter basket. Using the tamping tool, press down the grounds with moderate pressure and clean any excess from the rim.

Turn the Cuisinart® Espresso Maker on. When the machine is heated and ready to use, the red heating light will go out.

Secure the portafilter holder in place. Place a glass underneath the brew head and turn the function knob to the ☕ espresso setting. Espresso will begin to brew. After 1 cup has been brewed (after about 40 seconds), turn the large function knob to the off position. Repeat to have 2 cups in total. Stir sugar into combined espresso to dissolve.

Pour the espresso mixture in a bowl. Cool to room temperature. Cover with plastic wrap and place in freezer. At every hour, for about 5 hours in total, scrape the mixture with a fork to allow crystals to form.

To serve, layer equal amounts of granita and whipped cream in a parfait glass. Garnish with

shaved chocolate, if desired.

## Affogato

Makes 2 servings

- 2 measured scoops finely ground espresso or 2 espresso pods**
- 2 scoops vanilla ice cream**

Place the two-cup filter basket in the portafilter holder. Spoon the espresso grounds into the filter basket. Using the tamping tool, press down the grounds with moderate pressure and clean any excess from the rim.

Turn the Cuisinart® Espresso Maker on. When the machine is heated and ready to use, the red heating light will go out.

Secure the portafilter holder in place. Place two demitasse cups underneath the brew head and turn the function knob to the ☕ espresso setting. Espresso will begin to brew. When 3 ounces have been brewed (after about 25 seconds), turn the large function knob to the off position.

Place one scoop of ice cream in each of two individual dishes. Pour one espresso over each scoop of ice cream.

## Espresso Gelato

Makes 4½ cups (1.125 L)

- 2 measured scoops finely ground espresso or 2 espresso pods**
- 3 cups (750 ml) whole milk**
- 2 cups (500 ml) espresso beans**
- 1 cup (500 ml) brewed espresso**
- 10 large egg yolks**
- 1 cup (250 ml) granulated sugar**
- ¼ tsp (1 ml) of salt**

Place the two-cup filter basket in the portafilter holder. Spoon the espresso grounds into the filter basket. Using the tamping tool, press down the grounds with moderate pressure and clean any excess from the rim.



---

Turn the Cuisinart® Espresso Maker on. When the machine is heated and ready to use, the red heating light will go out.

Secure the portafilter holder in place. Place a glass underneath the brew head and turn the function knob to the  espresso setting. Espresso will begin to brew. When 1 cup has been brewed (after about 40 seconds), turn the large function knob to the off position. Reserve.

Pour milk into a medium sized, heavy-bottomed saucepan. Over medium-low heat, gradually bring the milk to a boil. Turn the burner off and stir in the espresso beans. Let steep for 15 to 20 minutes. Strain; discard beans.

Add the espresso to the steeped milk. Over medium-low heat, gradually bring to a boil.

While the milk/espresso mixture is heating, slowly whisk the sugar and salt into the egg yolks. Beat together until the mixture is light and thickened.

Once the milk/espresso mixture has reached a boil, slowly whisk  $\frac{2}{3}$  of it into the yolk mixture. Return the combined mixture to the remaining milk/espresso in the saucepan. Over medium-low heat, stirring constantly in a figure-eight rotation with a wooden spoon, heat the mixture until it coats the back of a spoon, about 4 minutes. This mixture must NOT boil or the eggs will overcook.

Strain into a container and cool to room temperature. Cover; refrigerate for 2 to 3 hours, or overnight.

Once properly chilled, process in a Cuisinart® Ice Cream Maker according to the unit's instructions.

## Tiramisù

Makes 4½ cups (1.25 L)

- 4 measured scoops finely ground espresso or 4 espresso pods**
- 3 large eggs**
- $\frac{3}{4}$  cup (175 ml) granulated sugar, separated**
- 1 (8-ounce) container mascarpone cheese**
- $\frac{1}{2}$  cup (125 ml) chilled heavy cream**
- 1 tablespoon (15 ml) water**
- $\frac{1}{4}$  tsp (1 ml) of salt**
- 2 cups (500 ml) brewed espresso, cooled**
- 2 tablespoons (30 ml) dark rum (optional)**
- 24 Savoiardi (crisp Italian ladyfingers)**
- $\frac{1}{4}$  tsp (1 ml) shaved bittersweet chocolate or unsweetened cocoa powder (for garnish)**

Place the two-cup filter basket in the portafilter holder. Spoon the espresso grounds into the filter basket. Using the tamping tool, press down the grounds with moderate pressure and clean any excess from the rim.

Turn the Cuisinart® Espresso Maker on. When the machine is heated and ready to use, the red heating light will go out.

Secure the portafilter holder in place. Place a glass underneath the brew head and turn the function knob to the  espresso setting. Espresso will begin to brew. When 1 cup (250 ml) has been brewed (after about 40 seconds), turn the large function knob to the off position. Repeat to brew a total of 2 cups (500 ml). Reserve.

Whisk together yolks and  $\frac{1}{2}$  cup (125 ml) sugar in a large bowl over a simmering pot of water. Whisk in rum. Continue whisking until the mixture is thick and pale and warm to the touch.

---

Using a Cuisinart® hand mixer with the beaters attached, beat in the mascarpone cheese, on the lowest level, until just combined. Reserve.

With the whisk attachment of the Hand Mixer, beat the cream to soft peaks. Gently fold in the whipped cream to the mascarpone mixture until just combined, but still streaky.

In another bowl, with a cleaned whisk attachment on the hand mixer, beat the egg whites, salt, and water, to soft peaks. While still beating, gradually add the remaining sugar and beat to medium-stiff peaks. Gently fold the meringue into the mascarpone/cream mixture.

In a shallow bowl, mix the espresso and rum. Dip 1 ladyfinger in, soaking each side for a few seconds, and transfer to an 8-inch (2-quart) glass baking dish. Repeat with 11 more and arrange in the bottom of the dish, trimming if necessary to cover the entire surface. It should be a tight fit. Reserve.

Spread half of the mascarpone/meringue mixture over the soaked ladyfingers. Make another layer of ladyfingers and spread an even layer of the remaining mascarpone mixture on top. Cover with plastic wrap and chill for at least 6 hours.

Before serving, sprinkle with the shaved chocolate or the cocoa powder.

---

# WARRANTY

## LIMITED THREE-YEAR

# WARRANTY

We warrant that this Cuisinart product will be free of defects in materials or workmanship under normal home use for 3 years from the date of original purchase. This warranty covers manufacturer's defects including mechanical and electrical defects. It does not cover damage from consumer abuse, unauthorized repairs or modifications, theft, misuse, or damage due to transportation or environmental conditions. Products with removed or altered identification numbers will not be covered.

This warranty is not available to retailers or other commercial purchasers or owners. If your Cuisinart product should prove to be defective within the warranty period, we will repair it or replace it if necessary. For warranty purposes, please register your product online at [www.cuisinart.ca](http://www.cuisinart.ca) to facilitate verification of the date of original purchase and keep your original receipt for the duration of the limited warranty. This warranty excludes damage caused by accident, misuse or abuse, including damage caused by overheating, and it does not apply to scratches, stains, discolouration or other damage to external or internal surfaces that does not impair the functional utility of the product. This warranty also expressly excludes all incidental or consequential damages.

Your Cuisinart product has been manufactured to the strictest specifications and has been designed for use only in 120 volt outlets and only with authorized accessories and replacement parts. This warranty expressly excludes any defects or damages caused by attempted use of this unit with a converter, as well as use with accessories, replacement parts or repair service other than those authorized by Cuisinart.

If the appliance should become defective within the warranty period, do not return the appliance to the store. Please contact our Customer Service Centre:

Toll-free phone number:

1-800-472-7606

Address:

Cuisinart Canada

100 Conair Parkway

Woodbridge, Ont. L4H 0L2

Email: [consumer\\_Canada@conair.com](mailto:consumer_Canada@conair.com)

### Model: EMC-100C

To facilitate the speed and accuracy of your return, please enclose:

- \$10.00 for shipping and handling of the product (cheque or money order)
- Return address and phone number
- Description of the product defect
- Product date code\*/copy of original proof of purchase
- Any other information pertinent to the product's return

\* Product date code can be found on the underside of the base of the product. The product date code is a 4 or 5 digit number. Example, 90630 would designate year, month & day (2009, June 30th).

Note: We recommend you use a traceable, insured delivery service for added protection. Cuisinart will not be held responsible for in-transit damage or for packages that are not delivered to us.

To order replacement parts or accessories, call our Customer Service Centre at 1-800-472-7606.

For more information, please visit our website at [www.cuisinart.ca](http://www.cuisinart.ca)

---

# Cuisinart®

S A V O R T H E G O O D L I F E®



Coffeemakers



Food  
Processors



Toasters



Rice Cookers



Cookware



Grills

Cuisinart offers an extensive assortment of top quality products to make life in the kitchen easier than ever. Try some of our other countertop appliances and cookware, and Savor the Good Life®.

**[www.cuisinart.ca](http://www.cuisinart.ca)**

©2012 Cuisinart  
100 Conair Parkway  
Woodbridge, ON L4H 0L2

100 Conair Parkway  
Woodbridge, ON. L4H 0L2  
Consumer Call Centre E-mail:  
[Consumer\\_Canada@Conair.com](mailto:Consumer_Canada@Conair.com)  
1-800-472-7606  
Printed in China

Any other trademarks or service marks referred to herein are the trademarks or service marks of their respective owners.

11CC127172

**IB-7261B-CAN**

---